



13th IEA Heat Pump Conference
April 26-29, 2021 Jeju, Korea

Test results of a Rotation Heat Pump and further developments

Andreas Längauer^{a*}, Bernhard Adler^a, Christian Rakusch^a

^aecop Technologies GmbH, Perfektastraße 73/Top A1, 1230 Vienna, Austria

Abstract

Strict regulations for refrigerants in terms of global warming potential (GWP) force industries and suppliers to develop new compressors, working fluids and lubrication systems. In contrast of solving these challenges, the Rotation Heat Pump (RHP) is based on a completely new principle and design which eliminate them via a fully integrated system. The compression in a RHP, which uses a nontoxic, ecologically friendly and not flammable working fluid, is based on centrifugal forces. This results in a very high compression efficiency of more than 99% and furthermore in a high coefficient of performance (COP). The process itself relies on a Joule cycle where the heat transfer is sensible and the working fluid is always gaseous. As a consequence, the process is not depending on the critical point of the fluid. A Rotation Heat Pump K7, developed during the last few years, was installed in January 2019 at the customers site and performance data has been collected since then. These results will be shown additionally to further examples of tests which have been done at a test rig. The advantage of flexibility in terms of temperature as well as the performance (COP) are shown in different charts. The next step of engineering is the development of a RHP-M2, which will provide a maximal thermal power at the sink of 2 MW. Additionally, some new arrangements will allow a temperature spread between sink and source of about 100 K. Another new feature will be special heat exchangers which will enable advanced operation modes. A further possibility for a new design is the downscaling to a 10 kW RHP, which would be possible to use in a standard household.

© HPC2020.

Selection and/or peer-review under responsibility of the organizers of the 13th IEA Heat Pump Conference 2020.

Keywords: Rotation Heat Pump, High Temperature, COP, Energy Efficiency

1. Introduction

Reducing CO₂-Emissions has to be the main target to keep the global warming in a bearable range for mankind to save biodiversity and human well-being. Many different aspects have to be accounted, processes have to be optimized and new technologies need to be applied to use renewable energy. Knowing that heat takes a major part of emitting CO₂, it is essential that heat pumps find their way not only further to space heating but also to industries and district heating. Additionally, it is necessary that heat pumps are using refrigerants with a very low Global Warming Potential (GWP) to ensure an environmentally friendly implementation. During the last years a lot of engineering has led to different low-GWP working fluids which may have some kind of disadvantage in terms of flammability and toxicity. In contrast to those fluids a Rotation Heat Pump (RHP) is using a mixture of noble gases, which GWP is zero and is neither flammable nor toxic. This is possible due to the used counterclockwise thermodynamic cycle, based on the Joule process. It means that the working fluid is always gaseous and is not condensing or evaporating in the heat exchangers. The big challenge to ensure an efficient system is, as for commercial heat pumps as well, the efficiency of the compression. In a RHP this challenge has been overcome by using centrifugal forces in a rotating domain to compress the gas. A short introduction how this compression has been realized and how it works will be given in the next section, details about that can also be found in [1], [2], [3] and [4].

* Corresponding author. Tel.: +43 -1-865-10-62-27
E-mail address: andreas.laengauer@ecop.at

This paper deals mainly with measured results, gained at a test rig as well as in a final application, to demonstrate the function and advantages of this principle.

2. Function and Design

A Rotation Heat Pump is based on two main components which are the rotor and the housing. The rotor is the essential part for the realization of the thermodynamic cycle because it provides through the rotation the compression and expansion of the working fluid. Also, the heat exchangers are mounted on the rotor which means that they are in motion during the process. The housing and additional components ensure the electrical supply, encapsulate the rotor and transfer the process fluids of sink and source into the rotating domain. In Figure 1 the design of a RHP is shown, on the left hand side the entire machine with the upper case removed and on the right hand side a pair of heat exchangers and the pipe system.

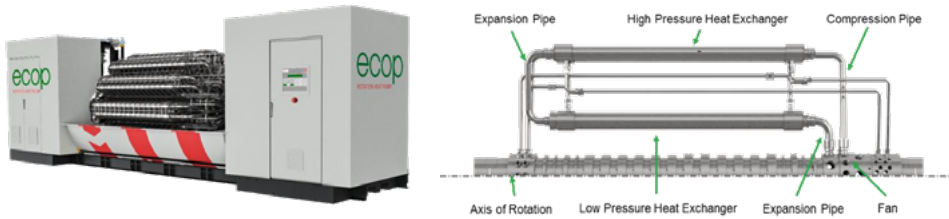

Figure 1: Design of a Rotation Heat Pump

In addition to the mechanical design, the following Figure 2 shows the Temperature-Entropy diagram (left) corresponding to the design and presents the thermodynamic cycle of the working fluid in the rotor (right) based on CFD (Computational Fluid Dynamics) calculations. The shown temperatures are just an example, the process can be shifted to different temperature levels easily, while the Coefficient of Performance (COP) remains almost constant. The temperature increase (5.2 to 2) is caused by the compression based on the centrifugal forces and vice versa the expansion (3 to 4 and 5 to 5.1). Heat is transferred from the working fluid to the sink (2 to 3) and from the source to the working fluid (4 to 5). A fan ensures the mass flow in the system and provides the exergy to the process via an electrical motor. The rotational speed of the fan can be controlled independently of the speed of the main rotor by using a separate frequency converter for this engine. The fan basically acts like a commercial compressor but consists of special designed blades. More details about the function and design are represented in [2] and [4].

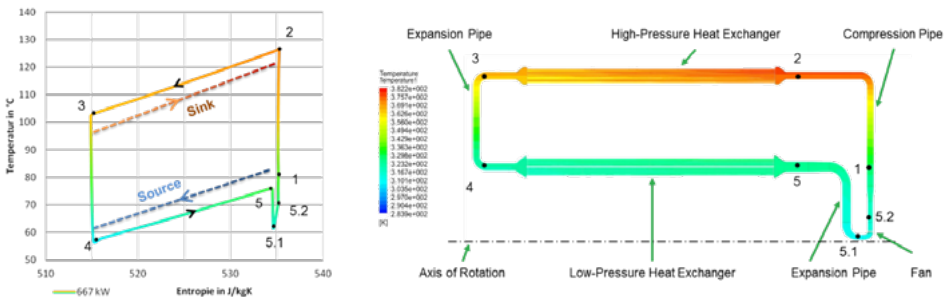

Figure 2: Joule cycle (left) and corresponding design (right) of a Rotation Heat Pump

2.1. Calculation of the Coefficient of Performance (COP) for a RHP

A common used, representative parameter for characterizing the efficiency of a heat pump is the Coefficient of Performance (COP). Also, for the Rotation Heat Pump the COP can be calculated by using the thermal power at the output and the electrical power consumption. The ratio of those values represents how many times thermal power is provided at the output (sink) compared to the input of electrical power. The electrical power consumption of a RHP is mainly caused by the engines of the fan and the rotor. Since they are measured

separately, a COP of the thermodynamic process itself can be calculated as well when considering only the power of the fan. The used expression for calculating the COP is

$$COP = \frac{\dot{Q}_{sink}}{P_{electric}} \quad (1)$$

where \dot{Q}_{sink} is the thermal power at the sink and $P_{electric}$ is the electrical power consumption, all given in W. If only the fan is used for the power consumption and calculation the efficiency is named $COP_{Process}$.

3. Testing

To test the Rotation Heat Pump two different ways are presented, first the combination with a test rig to show short term tests and second the results of an operation period of three days in the final application at the customer site. The data of the test rig arrangement should give an initial impression about how the system responds to planned changes while the second data set points out possible boundary conditions in the field application and how a RHP can deal with them.

3.1. Test rig

As already presented in [5], the test rig and Rotation Heat Pump are installed like shown in Figure 3 for testing and evaluating data. Different sensors to measure mass flow, temperature, pressure, rotation speed, electrical power and so on, are installed and values are stored on a flash device. Since for the evaluation and testing of specific design points it was not necessary to run the system for long time at constant parameters. Those tests are therefore considered as short-term tests in contrast to the following section about the installation at the customer site where data of the RHP over 72 hours is shown.

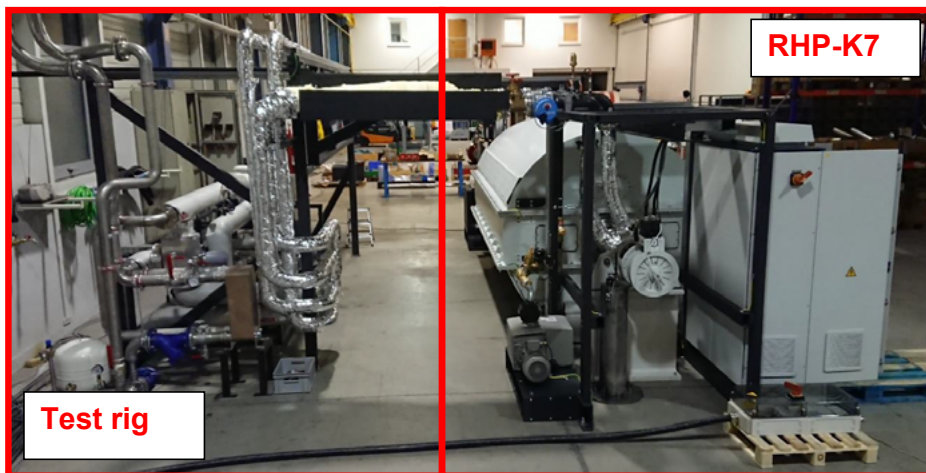

Figure 3: Overview test rig and RHP-K7 [5]

The test setup shown in Figure 3 can be represented as a scheme including sensors and hydraulic connections as well. The scheme (Figure 4) also includes all heat exchangers and pumps which are used for heat recovering/transferring and providing fluid flow. To adjust temperatures and thermal power of the system to a certain design point, the valves V1 and V2 can be controlled via remote control or the touch panel. The positions of the mentioned sensors are shown as well as the engines. For evaluating the electrical power consumption, the frequency converters have been used. Details about the test rig can be found in [5].

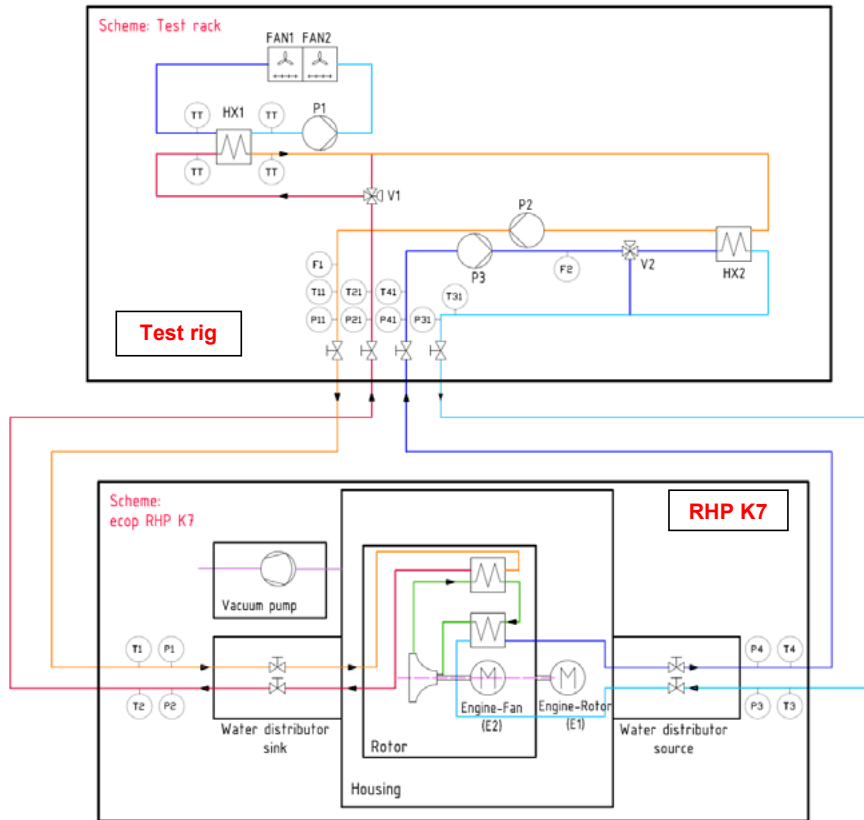

Figure 4: Simplified scheme of the test rig and RHP-K7

The collected measurement data was used to evaluate the COP corresponding to the temperature of sink and source and the rotational speed. The temporal development of temperatures, speed, mass flow, power and COP are stated in the following diagrams.

The first arrangement of measurement curves shows the response of the system to slow changes in temperature, see Figure 5 and Figure 6. Due to the fact, that the temperature spread between sink and source is constant as well as the mass flow and the rotational speed, the COP is remaining almost constant. The temperature level as displayed is changing to some of 15K at sink and source which is representative for changing conditions due to a day-night cycle for example. Further information about the dependence of the COP to the thermal power and the temperature lift will be discussed later with respect to the results of the field application. The results of the test rig demonstrate mainly the flexibility in terms of temperature level and the possibility to reach high temperatures.

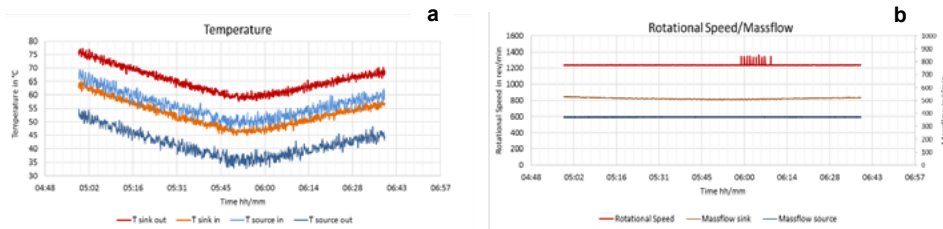

Figure 5: Temperature of sink and source (a), mass flow and rotational speed (b)

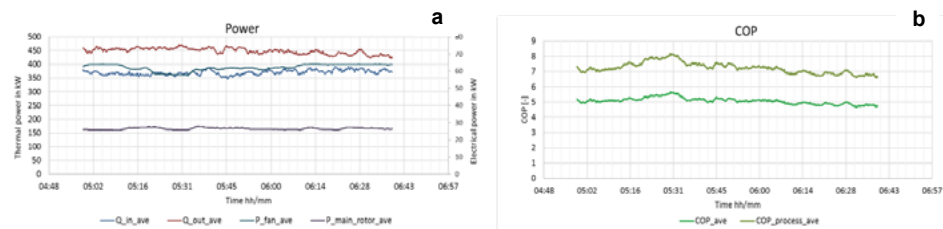

Figure 6: Thermal and electrical power (a), COP (b)

To demonstrate the possibility of switching from a lower temperature level to a higher one, the following figures show the temperature drift from around 65°C to about 90°C output temperature at the sink. The spread between sink and source is again kept constant and so the COP is at an almost constant level. The reason for differing to the constant operation mode (04:19h to 05:02h, Figure 7 and Figure 8) is caused by the fact, that the system is not balanced in terms of energy. To increase the temperature level more energy input is necessary than at the output appears. Thus, the power at the output is less than at constant conditions and also the COP is affected. However, when reaching a steady state, the power and COP are at the same level as before the dynamic increase. Figure 7 and Figure 8 show the described behavior.

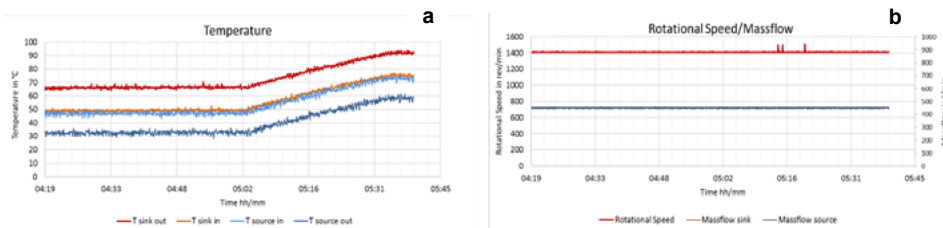

Figure 7: Temperature of sink and source (a), mass flow and rotational speed (b)

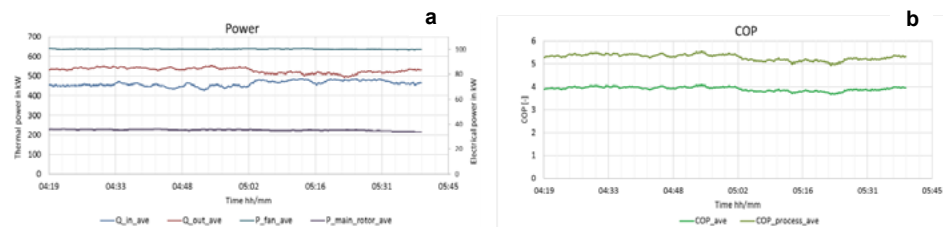

Figure 8: Thermal and electrical power (a), COP (b)

Further data of tests from the test rig are mentioned in [5] where some representative test cases have been analysed additionally.

3.2. Field application

After the previous described tests in combination with a test rig, the RHP has been installed at the customers site where further tests have been performed. Of course, it is not possible to provide boundary conditions as flexible as at the test rig but it is also essential to validate the function in field applications. In the following Figure 9 the field installation of the first RHP-K7 is shown. On the left-hand side the control cabinet for power supply including frequency converters is represented while on the right-hand side the control cabinet for the programmable logic controller is installed. The closed main housing including the rotor is located in between. The data of the following paragraphs show measured values of three consecutive days.



Figure 9: RHP-K7, field installation

Results in terms of measured data of the field installation show the daily variation of temperatures and also, since the mass flow was kept almost constant, the variation of power and COP. This is based on the fact, that the RHP has not been run in optimization mode. To ensure a maximum COP the mass flow as well as the rotational speed can be dynamically adjusted by a programmable logic controller. This feature has not been used during the measurement period and so the COP is sometimes dropping to a lower level and also rising to a higher one. Another fact which should be mentioned, is the general operation at an off-design point. The designated thermal power of the RHP-K7 is 700 kW at the sink, for this power all components are designed and optimized for. Since during the time of testing only 100-600 kW have been needed at the sink, the optimal operation point has not been reached.

The following figures show always a measuring duration of 24h, each day is constituted by a set of 4 diagrams including same measurands and calculated values as in the test scenario described in the previous section. Each figure states out, that the temperature of the source is increasing after appr. 07:00h until it remains almost constant after approximately 13:00h. The decreasing of the source temperature begins at around 17:00h on day two and three while on the first demonstrated day it starts more spontaneous at around 14:00h. The drop of source temperature at 14:24h is caused by switching on an internal fan of the CHP plant, where the RHP is integrated, for cooling the source. Thus, it is a change of boundary conditions due to external circumstances which results in this staircase for the supply temperature. But, as the diagram shows as well, it is not a problem to keep the thermodynamic process ongoing.

The peak of thermal power always corresponds with an increased electrical power consumption of the fan while the power for the main rotation is always almost constant. The reason for this behavior of power consumption of the fan engine is the divergence of the isobars. If more heat is transferred from the working fluid to the process fluid, it is necessary that the fan overcomes the increased pressure difference caused by this divergence. This can be seen in Figure 2 where the pressure increase by the fan is shown from point 5.1 to 5.2 in the T-s-diagram. It is the same effect as it is used in turbines for power transformation based on the clockwise Joule-cycle. For the Rotation Heat Pump, it means, that the more thermal power is transferred, the more electrical power is necessary. Furthermore, this divergence also depends on the temperature lift between the source and the sink provided by the rotational speed of the main rotor. It can be stated, that the higher the temperature lift and the more heat transferred, the higher is the necessary pressure increase and the electrical power consumption of the fan. The power consumption of the main rotor in turn is always constant at a certain rotational speed. This value mainly depends on the friction of sealings and bearings.

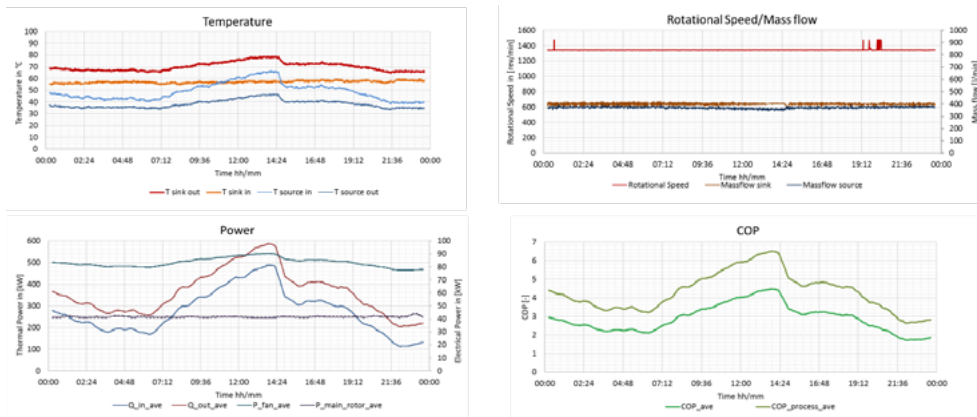

Figure 10: Test data, 1st day

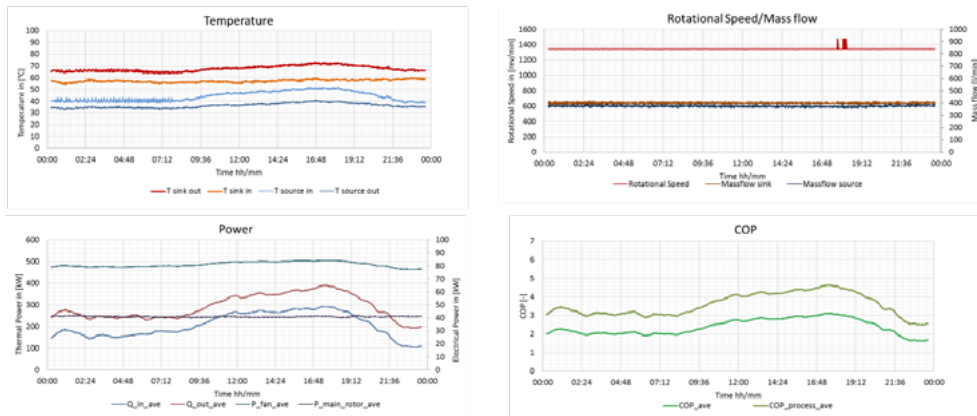

Figure 11: Test data, 2nd day

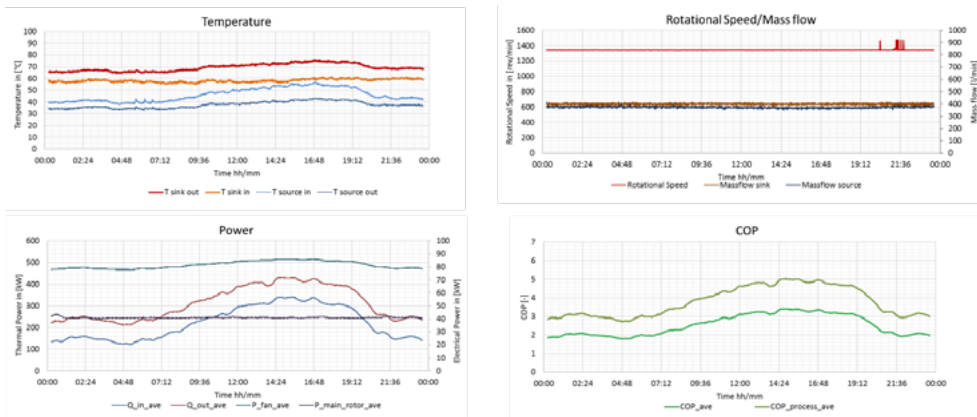

Figure 12: Test data, 3rd day

4. Further developments

To show the potential of a rotation heat pump and the joule-cycle based on centrifugal compression, some further developments will be shown. Right now, the focus is based on industrial applications, which make sense because there is a huge potential to reduce CO₂ emissions in this area. This fact is targeted by the development of a RHP-M2 which will provide 2 MW of thermal power at the sink. This type of machine will also allow a temperature lift of appr. 100K because internally there are two separated gas-cycles which can be switched from parallel to serial operation mode. Therefore, the mass flows of sink and source are split up and an intermediate circuit of process water is used. This operation mode allows a high lift but, in this case, the thermal power output at the sink is reduced to 1 MW.

However, the aim is also to reduce refrigerants with a high GWP in the field of space heating and refrigeration. Compared to the design of actual Rotation Heat Pumps, supplying 700 kW thermal power, it needs just some adaptations for downscaling to smaller machines of around 1- 10 kW. This power range is fitting good for household installations. The main principle, the compression via centrifugal forces, will not change but in terms of size those machines will be quite smaller. Another promising approach would be the development of a “Rotation Chiller” for supplying cold in refrigeration systems in combination with an environmentally friendly working fluid. In Figure 13 the actual designs are shown as well as the planned developments corresponding to the temperature level at the sink and the thermal output.

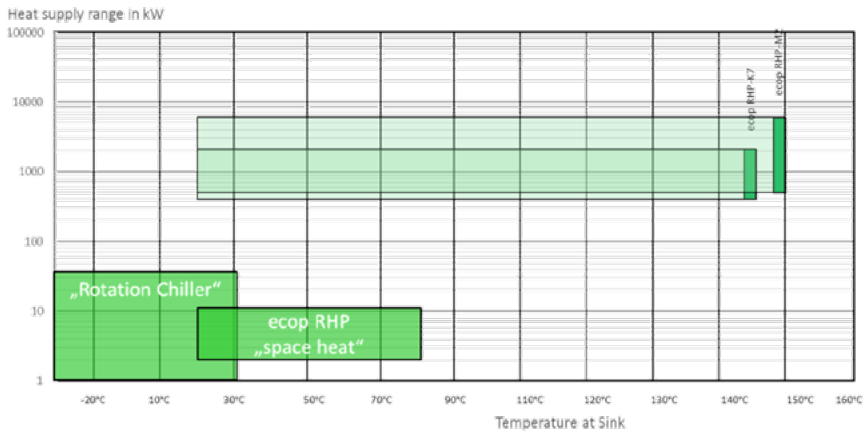

Figure 13: Actual designs and further developments

One further advantage is the design flexibility concerning the arrangement of heat exchangers. Right now, they are installed in parallel to the axis of rotation which makes sense for transferring sensible heat with an optimal temperature spread of sink and source according to the mass flow of the working fluid. But, since the incline of the heat exchangers can be seen as a degree of freedom to adjust the process, the thermodynamic cycle can be optimised for many different operating conditions (Table 1). It is a big advantage, that the heat capacity rates need not to be equal for minimizing exergy losses of the heat exchangers. The drawback of this layout is finally, that the design is more complex compared to the standard layout.

A positive incline of both, the low-pressure and high-pressure heat exchanger, enables the possibility to realize a thermodynamic process quite close to the Carnot-cycle. The reason therefore is the heat transfer during the working fluid is further compressed in the heat exchanger. That arrangement would fit perfect for high mass flows at sink and source while the temperature spread is quite low for a certain power output.

The opposite, the negative incline of the heat exchangers uses the cooling based on the expansion of the working fluid during the flow to a lower diameter of the rotor. The transferring of heat during this expansion allows further cooling and therefore a high temperature spread of sink and source is possible. So, the thermal power can be provided by having a low mass flow but high spread in terms of temperature.

The last two examples shown in Table 1 demonstrate the possibility to incline only one heat exchanger. This may be an advantage if there is a sink with low mass flow and high temperature spread in combination with a moderate cool down of the source, demonstrated by the negative incline of only the source. The last

case presents the positive incline of the source-heat exchanger, this would be most efficient if the mass flow of the source is high and the temperature spread is low. The sink in this case is not adjusted.

Table 1: Possible arrangements of the heat exchangers and corresponding T-s-Diagrams (schematic)

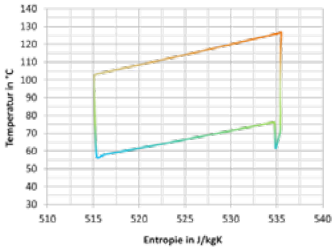
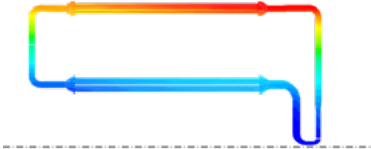
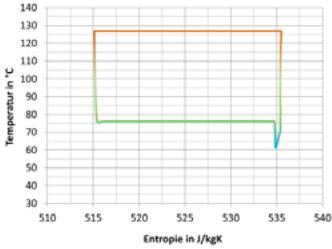
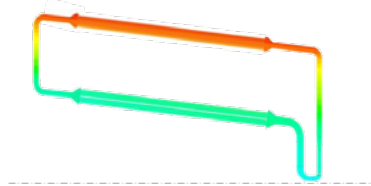
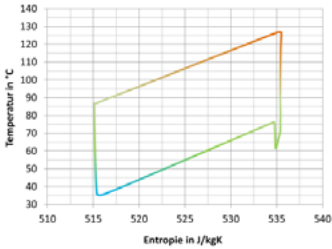
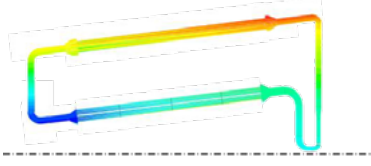
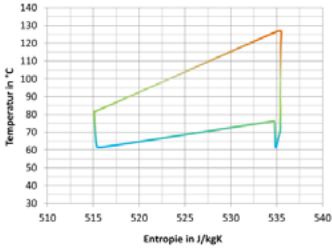
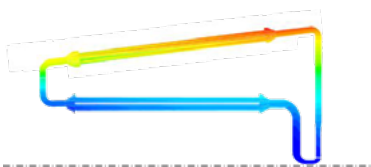
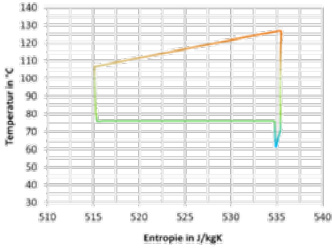
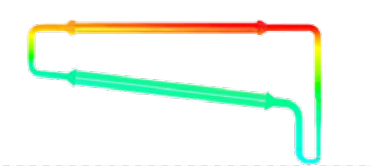
	T-s-Diagram	Heat exchanger arrangement
Standard design		
Positive incline (small spread of sink and source)		
Negative incline (large spread of sink and source)		
Positive incline at sink (large spread of sink)		
Negative incline at source (small spread of source)		

5. Conclusions

After different studies about the principle and function of a Rotation Heat Pump (RHP) have been published, test results are now available. In addition to the measurement data, gained at a test rig and a field installation, also a short introduction about the main principle and design of a RHP is given in this paper.

The first reference plant of a RHP-K7 has been manufactured and assembled as well as been tested. For simulating various operation modes by providing different boundary conditions in terms of temperature and mass flow of sink and source, a custom test rig was used. All necessary sensors have been installed while by using different heat exchangers, pumps and control valves the system was controlled and measurement data was collected. A scheme of the test rig and RHP present the setup and allow to comprehend the system. The focus of this installation was put on showing the flexibility in terms of temperature but also to verify the achievement of high temperatures at the output. Both cases are visualized via measurement data in diagrams and confirm these functions. Further, it is demonstrated, that at constant mass flow and rotational speed the temperature level can be easily adjusted without affecting the efficiency.

Beside the test application, the field installation was used to gain data of three consecutive days of operation. Relevant sensors have been logged again and measurement values have been analyzed in each case to calculate the Coefficient of Performance as a representative value for the efficiency. Since the system was not run in an optimization mode, the mass flow was kept constant and also the rotational speed. The input temperatures have been varying as they were depending on the operation of a CHP-plant where the RHP is implemented. In contrast to the boundary conditions at the test rig, the input temperature of sink and source have been changing not in a uniform way but much more irregular. Thus, the supplied thermal power and also the electrical power consumption were affected. The relation of those values to the temperature is analyzed and discussed where the divergence of the isobars plays a key role.

To give an outlook for further development possibilities, new fields of application are listed as well as design studies to optimize the thermodynamic process. Because the principle of centrifugal compression is also efficient in small scales, besides the upscaling of the RHP-K7 (700 kW) to the RHP-M2 (2 MW) the downscaling for space heating is of major interest. The changing of design parameters like the incline of the heat exchangers is a new degree of freedom for a heat pump and is introduced. Because of this option, it is possible to adjust the thermodynamic process exactly for individual implementations. These research projects are discussed in a last section where advantages and disadvantages are mentioned.

Acknowledgements



This project has received funding from the European Union's Horizon 2020 research and innovation programme under grant agreement No 823463.

References

- [1] Adler, B., et al., Centrifugal compression turbo heat pump made by ECOP, 10th IEA Heat Pump Conference, Tokyo, Japan, 2011
- [2] Adler B., Riepl, S., Heat pump for process industry, 11th IEA Heat Pump Conference, Montreal, Canada, 2014
- [3] Adler, B., et al., Industrieller Einsatz einer Rotationswärmepumpe, DKV-Tagung, Bremen, Germany, 2017
- [4] Adler, B., Mauthner, R., Rotation Heat Pump (RHP), 12th IEA Heat Pump Conference, Rotterdam, Netherlands, 2017
- [5] Adler, B., et al., COP tests of a Rotation Heat Pump, 25th IIR International Congress of Refrigeration, Montreal, Canada, 2019